

**AQT-56SE**

**ELECTRONIC SERIES**



**PROGRAMMING MANUAL**

---

## TABLE OF CONTENTS

General Residential Installation	3
AQT-56SE Keypad	4
Control Operation	5
Master Programming - Setting the Time of Day	6
- Setting the Regeneration Mode	7
- Setting the Unit Capacity	8
- Setting the Regeneration Time & Hour Override	10
- Setting the Backwash Time	11
- Setting the Brine Time	12
- Setting Rapid Rinse Time	13
- Setting Brine Tank Fill Time	14
Product Features	15
AQT-56SE Dimensional Drawings	18
AQT-56SE Control Assembly	19
AQT-56SE Control Assembly Parts List	20
AQT-56SE Valve Body Assembly	21
AQT-56SE Valve Body Assembly Parts List	22
3/4" Turbine Assembly & Parts List	23
Valve Wiring Diagram	24
Troubleshooting	25
Notes	26

---

Water Pressure	Minimum 25 PSI
Electrical Supply	Uninterrupted AC. Check voltage compatibility
Existing	Free of any deposits or build-ups inside pipes
Softener	Locate close to drain and connect according to plumbing codes
Bypass Valves	Always provide for bypass valve if unit is not equipped with one

<b>CAUTION</b>	
 <b>WARNING</b>	Do not exceed 120 PSI water pressure
	Do not exceed 100°F water temperature
	Do not subject unit to freezing conditions

### General Valve Installation Procedure

Note: Install the water softener with the inlet, outlet and drain connections made according to manufacturer's recommendations and to meet applicable plumbing codes.

1. Locate the softener tank close to a drain where you wish to install the unit. Note: Be sure the tank is level and on a firm base.
2. Perform all plumbing according to local plumbing codes.
  - Use a 1/2" minimum pipe size for the drain.
  - Use a 3/4" drain line for backwash flow rates that exceed 7 gpm or length that exceeds 20' (6 m).

3. Cut the 3/4" distributor tube (1.050 O.D.) flush with top of each tank.

Note: Only use silicone lubricant.

4. Lubricate the distributor O-ring seal and tank O-ring seal. Screw the valve on to the tank.
5. Use only Teflon tape on the drain fitting. Solder joints near the valve must be done before connecting any piping to the valve. Always leave at least 6" (152 mm) between the valve and solder joints when soldering pipes that are connected to the valve. Failure to do this could cause damage to the valve.
6. Be sure the floor under the brine tank is clean and level.
7. Add water until there is approximately 1" (25 mm) of water above the grid plate. If a grid is not utilized, fill to the top of the air check in the brine tank. Do not add salt to the brine tank at this time.
8. On units with a bypass, place in Bypass position.
  - Turn on the main water supply.
  - Open a cold soft water tap nearby and let water run a few minutes or until the system is free of foreign material (usually solder) resulting from the installation. Close the water tap when water runs clean.
9. Place the bypass in the In Service position and let water flow into the mineral tank. When water flow stops, slowly open a cold water tap nearby and let water run until air is purged from the unit. Then close tap.
10. Plug the valve into an approved power source

# AQT-56SE

Keypad

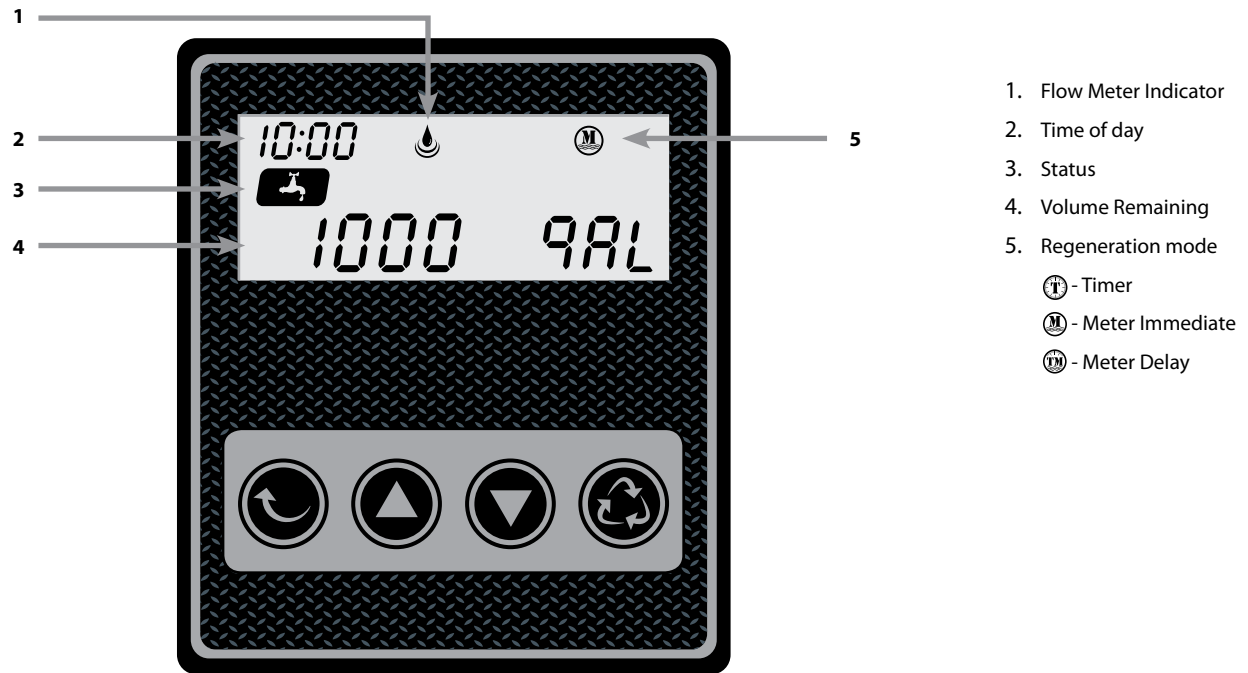

### Settings Button

1. Enter into setting menu
2. Confirm the current setting, and enter into the next step
3. When used simultaneously with up button, will enter into master programming



### Up Button

1. Adjust current settings (increase)
2. Go to the last step



### Down Button

1. Adjust current setting (decrease)
2. Go one step back



### Cycle Button

1. Save the setting and return to service
2. Enter into queued regeneration mode
3. A long press for 5-6 seconds, initiate a immediate regenerate
4. Terminate the current regeneration step and goes to the next step



### Time Clock Delayed Control

A Time Clock Delayed Control regenerates the system on a timed interval. The control will initiate a regeneration cycle at the programmed regeneration time when the number of days since the last regeneration equals the regeneration day override value. The interval time can be programmed in a 24 hours base (1 day). Example, 24, 48, 72, 96, and so on. Or each 3, 4, 6, 8 or 12 hours if your need is less than 24 hours.



### Meter Immediate Control

A meter immediate control measures water usage and regenerates the system as soon as the calculated system capacity is depleted. The control calculates the system capacity by dividing the unit capacity (typically expressed in grains/unit volume) by the feed water hardness and subtracting the reserve. Meter Immediate systems generally do not use a reserve volume. A Meter Immediate control will also start a regeneration cycle at the programmed regeneration time if a number of days equal to the regeneration day override pass before water usage depletes the calculated system capacity.



### Meter Delayed Control

A Meter Delayed Control measures water usage and regenerates the system at the programmed regeneration time after the calculated system capacity is depleted. As with Meter Immediate systems, the control calculates the system capacity by dividing the unit capacity by the feed water hardness and subtracting the reserve. The reserve should be set to insure that the system delivers treated water between the time the system capacity is depleted and the actual regeneration time. A Meter Delayed control will also start a regeneration cycle at the programmed regeneration time if a number of days equal to the regeneration day override pass before water usage depletes the calculated system capacity.

### Control Operation During Regeneration

During regeneration, the control displays a special regeneration display. In this display, the control shows the current regeneration step number the valve is advancing to, or has reached, and the time remaining in that step. The step that displays, flashes until the valve completes driving to this regeneration step position. Once all regeneration steps are complete the valve returns to service and resumes normal operation.

### Control Operation During Programming

The control only enters the Program Mode with the valve in service. While in the Program Mode, the control continues to operate normally monitoring water usage and keeping all displays up to date. Control programming is stored in memory permanently, eliminating the need for battery backup power.

# Master Programming

## Setting the Time of Day

### First Step - Setting Time of Day

Press Simultaneously



Default setting 12:00 (24 hours)  
Press Settings Button and Up Button simultaneously to enter into Programming Mode

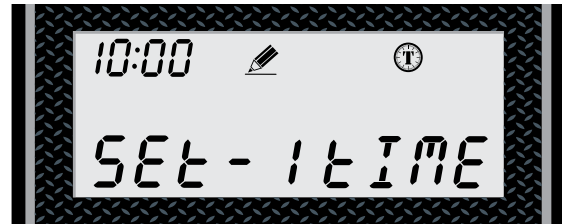

Flashing



### Set the hour

Press Up or Down buttons to change hours.



Press the Settings Button to accept and continue.



Flashing



### Set the minutes

Press Up or Down buttons to change minutes.



Press the Settings Button to accept and continue.



Flashing



**Second Step - Setting the Regeneration Mode**



Default setting is "Timer"

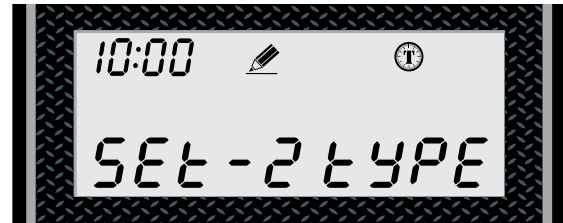

Flashing



**Choose Between Time, Meter Immediate or Meter Delayed**



Press Up or Down buttons to change mode

Press the Settings Button to accept and continue.

Timer  
This mode will not show water capacity options.



Flashing

Meter imm.



Flashing

Meter Delay



Flashing

# Master Programming

Setting the Water Capacity

## Third Step - Setting the Unit Capacity (Not shown if Timer Mode was selected in 2nd Step)



Default setting is 1000 gal

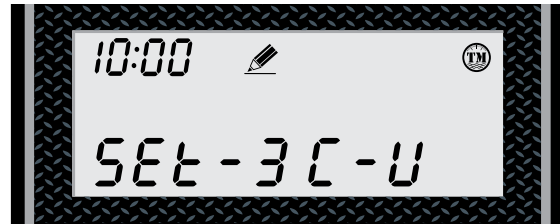

▲  
Flashing



## Set Unit Measurement - Gallons, Liters or Cubic Meters

Press Up or Down buttons to Change Unit between:

GAL: Gallon  
L: Liter  
M3: Cubic Meter



Press the Settings Button to accept and continue.



Gallons



▲  
Flashing

Liters



▲  
Flashing

Cubic Meters



▲  
Flashing

# Master Programming

Setting the Water Capacity

Press Up or Down buttons to set water capacity.



Press the Settings Button to accept, cursor moves left and the number flashes.



Flashing



Flashing



Flashing



Flashing



Flashing

# Master Programming

Setting the Regeneration Time & Hour Override

## Fourth Step - Regeneration Time and Hours Override

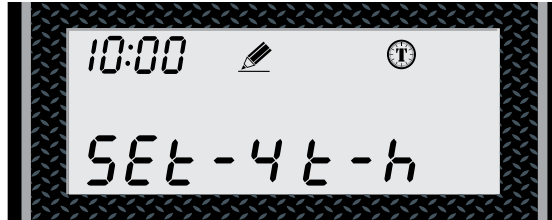

▲  
Flashing

### Timer Mode

Default: 2:00 a.m. – 072 hours

Hours Override range:

3, 4, 6, 8, 12 hours, then every 24 hours (24, 48, 72... 960)

### Meter Imm & Meter Delay Modes

Default: 2:00 a.m. – OFF

Hours Override range:

Every 24 hours (24, 48, 76... 960)

Use UP and DOWN buttons to adjust the Regeneration Time



▲  
Flashing

Use UP and DOWN buttons to adjust the Regeneration Time

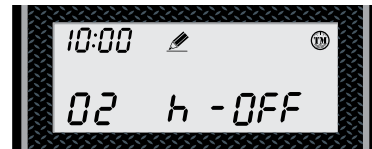

▲  
Flashing

Press SET to go to Hours Override

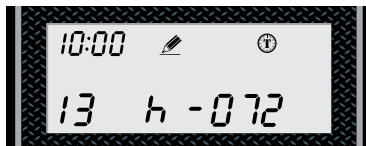

▲  
Flashing

Press SET to go to Hours Override

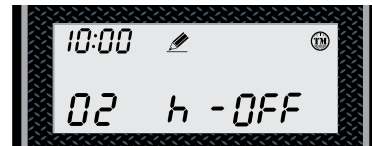

▲  
Flashing

Use UP and DOWN buttons to adjust Hours Override

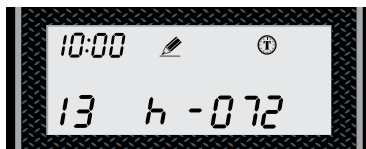

▲  
Flashing

Use UP and DOWN buttons to adjust Hours Override

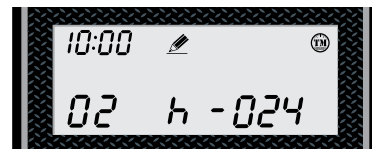

▲  
Flashing

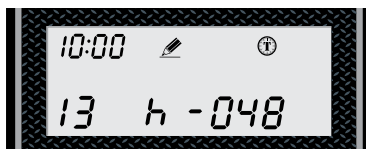

▲  
Flashing

**Fifth Step - Setting the Back Wash Time**

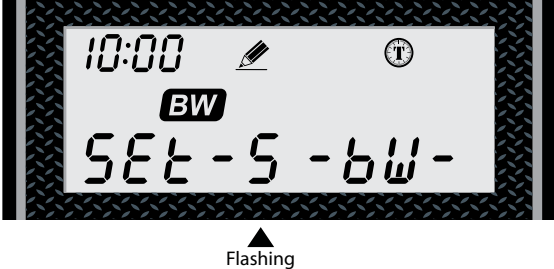

**Set the Time**

Default setting is 015

Press Up or Down buttons to change Back Wash time (Minutes)  
Range: 0 - 999



Press the Settings Button to accept and continue to next digit

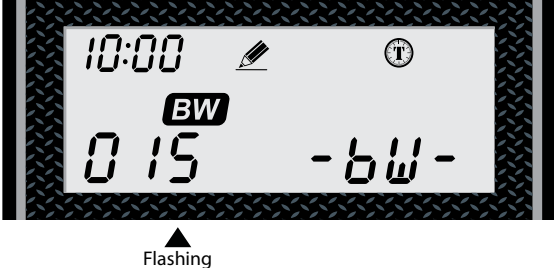
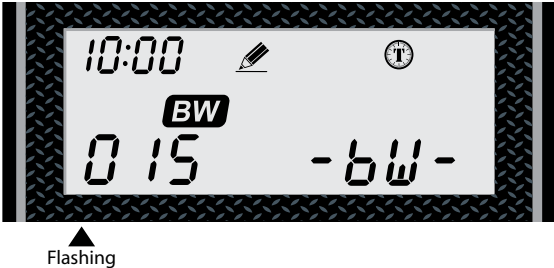

# Master Programming

Setting the Brine Time

## Sixth Step - Setting the Brine Time

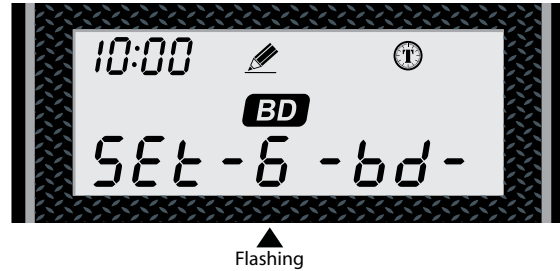

### Set the Time

Default setting is 060

Press Up or Down buttons  
to change Brine time  
(Minutes)  
Range: 0 - 999



Press the Settings Button  
to accept and continue  
to next digit

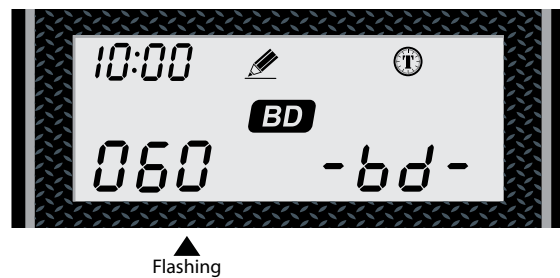
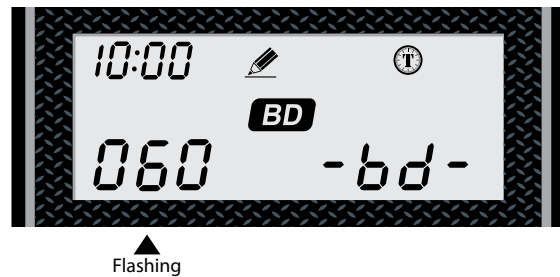
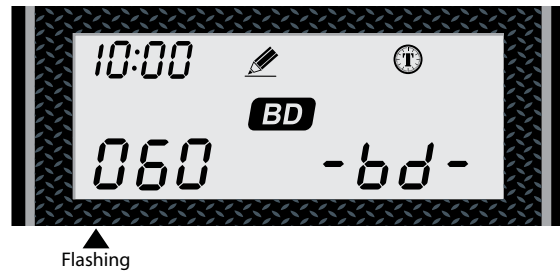

**Seventh Step - Setting the Rapid Rinse Time**

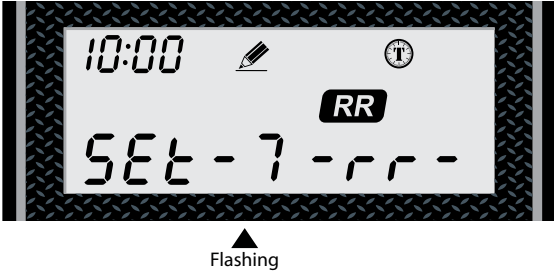

**Set the Time**

Default setting is 010

Press Up or Down buttons to change the Rapid Rinse time (Minutes)  
Range: 0 - 999



Press the Settings Button to accept and continue to next digit

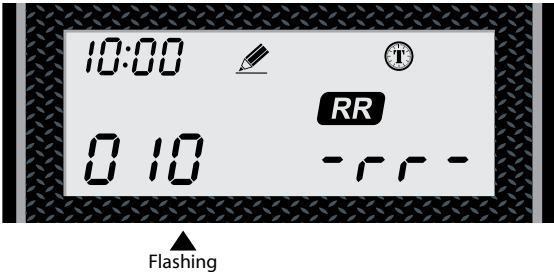
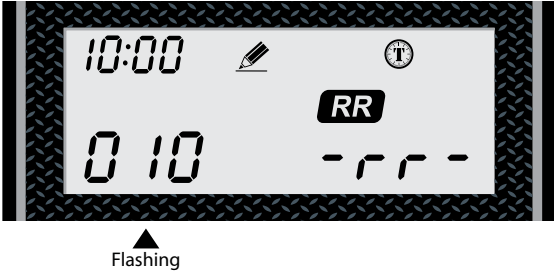
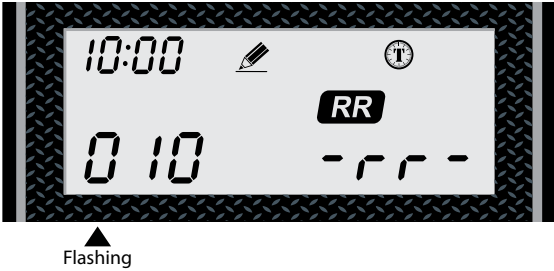

## Master Programming

Setting the Brine Tank Fill Time

### Eighth Step - Setting the Water Filling Time

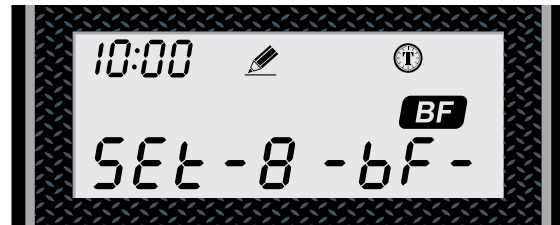

Flashing



### Set the Time

Default setting is 012

Press Up or Down buttons to change the Water Filling Time (Minutes)  
Range: 0 - 999



Press the Settings Button to accept and continue to next digit

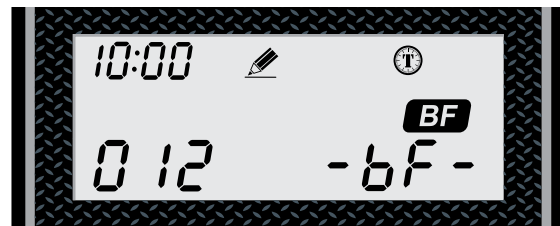

Flashing

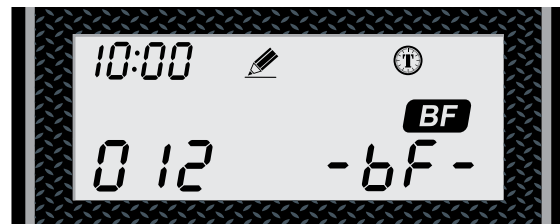

Flashing

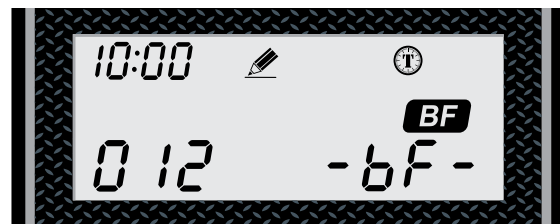

Flashing

**DONE**

### 1) Display in Service

#### Timed Regeneration Mode

The display will show the current time, remaining time to the next set regeneration, and the days override.



▲  
Reg. remaining time

▲  
Reg. override days

#### Meter Immediate Regeneration Mode

The display will show the current time and the remaining treated water to the next regeneration.



▲  
Reg. remaining capacity

#### Meter Delay Regeneration Mode

The display will show the current time and the remaining treated water alternatively. When the remaining treated water counts down to zero the display changes to the regeneration time set by the user.



▲  
Reg. remaining time

### 2) Backlight Screen

The backlight on the screen will go off automatically after one minute if no buttons are pressed. To light it up again press any button on the touch pad.

## Product Features

### Features & Displays

### 3) Memory during power failure

All program settings are stored in permanent memory. Current valve position, cycle step elapsed, time of day are stored during the power failure. Reset the current time is necessary when power up.



If the valve stopped at a regeneration stage when power failure, the valve will return to prior position when power up. It takes 4 to 5 minutes to reset to the position.

The display shows as: ►

The system will show the status when power failure after find the position.



### 4) Restore factory settings

- 1) Pull out the power
  - 2) Press the  button and plug in the power simultaneously
  - 3) Release the  button
- The system is now restored



### 5) Manual regeneration

#### Queued Regeneration

When the valve is in service position press the  button to activate the queued regeneration.

Queued Regeneration means the system will initiate a regeneration at the time set. If missed, it will initiate on the next day.

The display shows the Queued Regeneration in TIMER Mode



The display shows the Queued Regeneration in Meter (Delay) Mode



The display shows the Queued Regeneration in Meter Immediate Mode.

The system will initiate a regeneration - either the treated water remaining counts down to zero or the remaining time counts down to zero, whichever is first.



Alternating Display



### 5) Manual regeneration

#### Immediate Regeneration

When the valve is in service position, press and hold the  button for 5 seconds, an immediate regeneration will be initiated.

#### Examples:

"BW" Flashing (ready to "Backwash")



When the time counts down to zero or press the  button

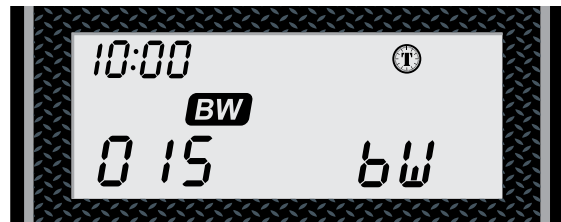



"BD" Flashing (ready to "brine")



The display shows as:



#### Stop Regenerating

When regenerating, press the   simultaneously, then stop regenerating the display will return to the service position.

# AQT-56SE

## Dimensional Drawings

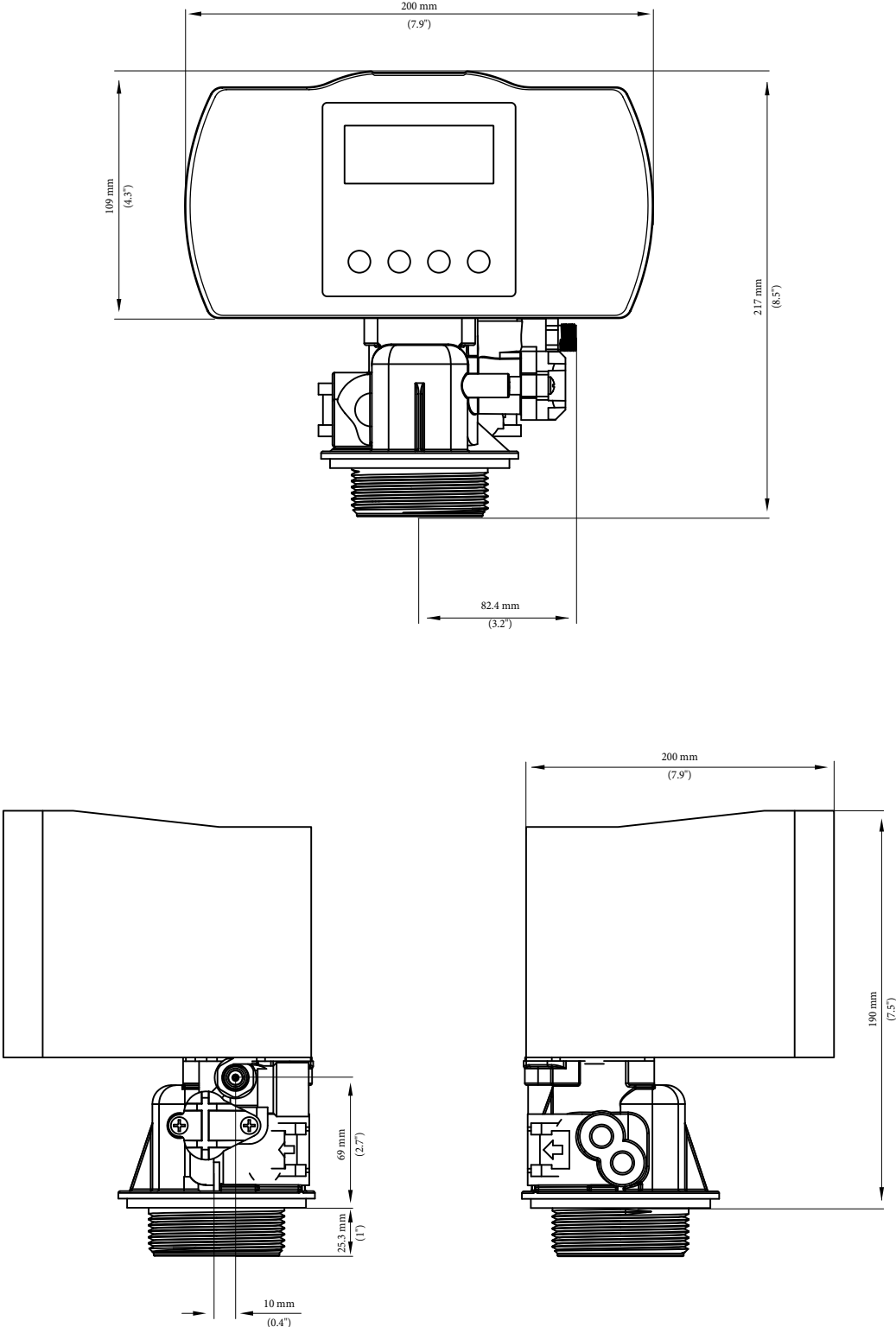

**AQT-56SE Control**  
Assembly

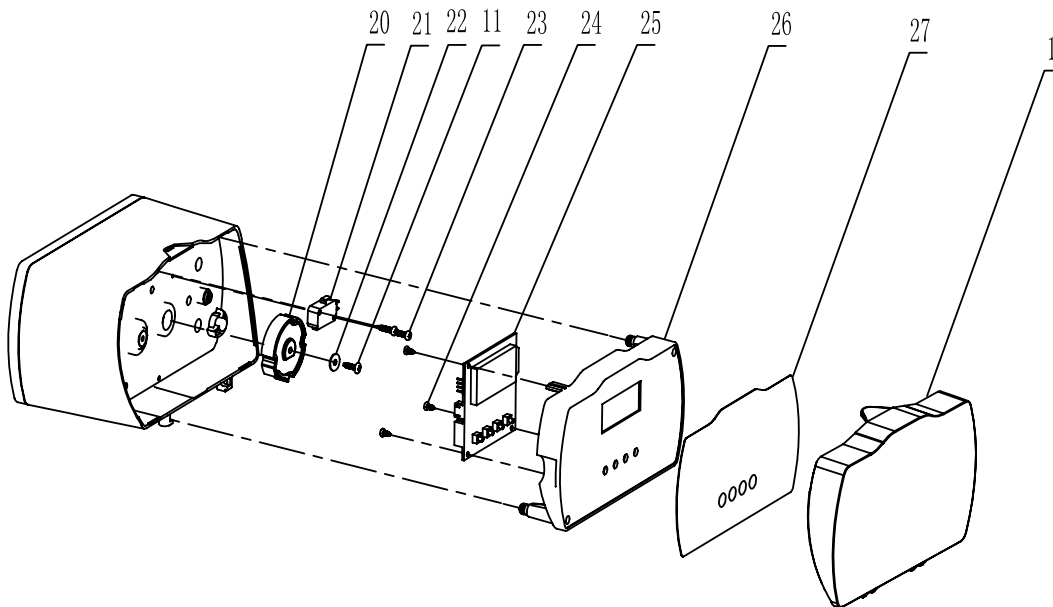
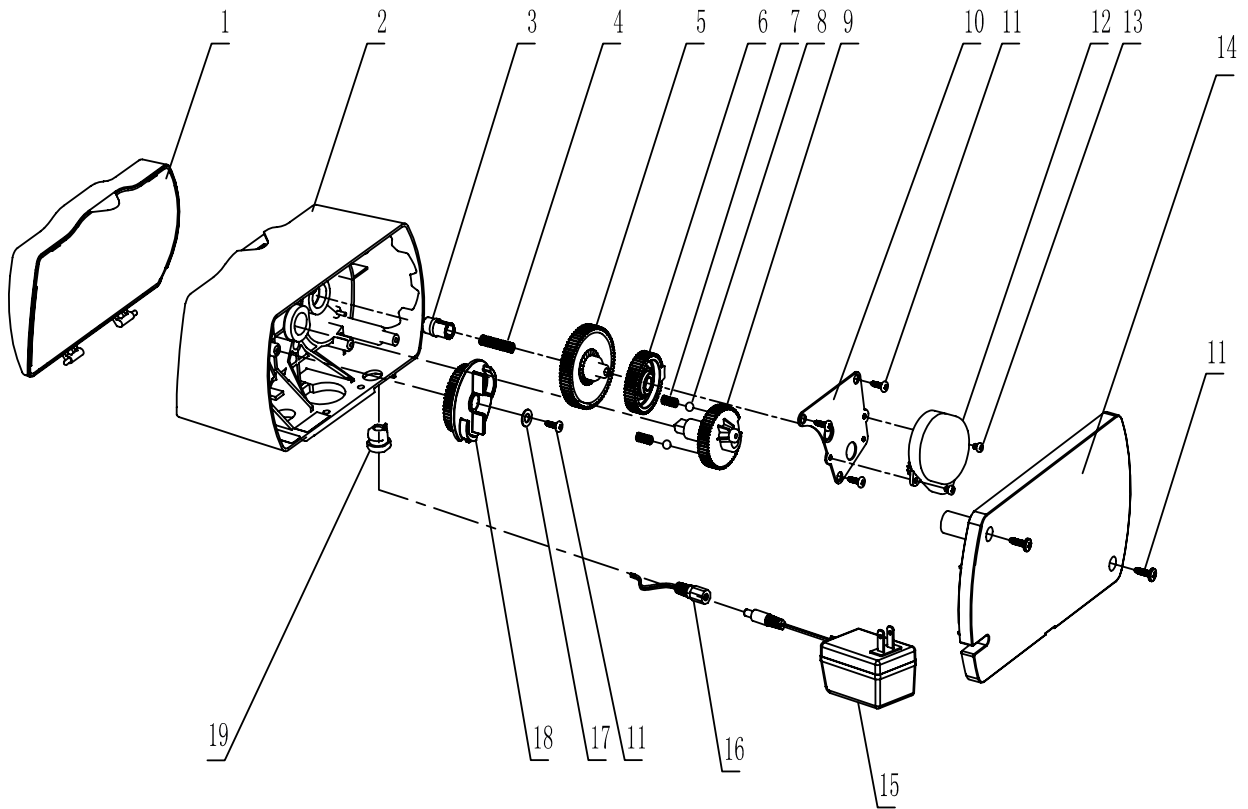

## AQT-56SE Control

### Assembly Parts List

---

Item No.	Quantity	Part No.	Description
1	1	A-15613	Front Cover
2	1	A-14448	Head Assembly
3	1	A-13018	Idler Pinion
4	1	A-13312	Spring Idler
5	1	A-13017	Idler Gear
6	1	A-13164	Drive Gear
7	2	A-14457	Spring, Detent, Main Gear
8	4	A-13300	Ball 1/4", SS
9	1	A-13170	Main Gear and Shaft
10	1	A-13175	Motor Mounting Plate
11	6	A-13296	Screw
12	1	A-13265F	Motor 24V, 60Hz
13	3	A-11384	Screw, Motor and Ground Wire
14	1	A-15614	Back Cover
15	1	A-19674	Transformer 24V, 60Hz
16	1	A-19674-PP	Power Plug
17	1	A-12037	Washer Plain, #10, 18-8 SS
18	1	A-60514-01	Brine Cam Assembly, 7-30 lbs
	1	A-60514-02	Brine Cam Assembly, 4-6 kg
	1	A-60514-03	Brine Cam Assembly, 3.5-15 lbs
19	1	A-13547	Strain Relief
20	1	A-17438	Drive Cam
21	1	A-60320-03	Micro Switch
22	1	A-04002	Washer Plain
23	1	A-02054	Screw
24	1	A-02015	Screw
25	1	A-07220F	Electronic Board for AQT-56SE
26	1	A-61672	Panel
27	2	A-56296	Front Label

# AQT-56 Valve Body

Assembly

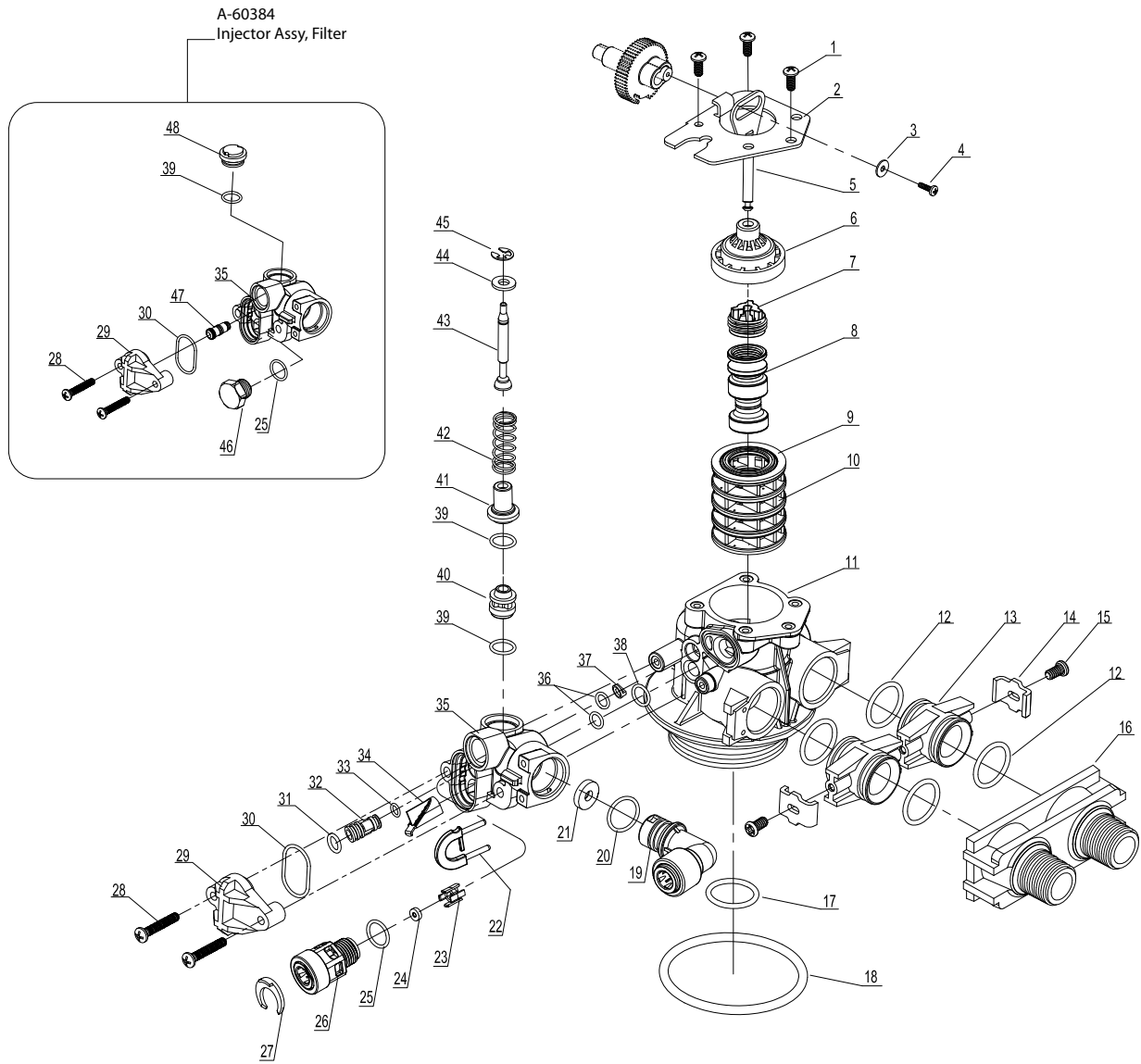

# AQT-56 Valve Body

## Assembly Parts List

Item No.	Quantity	Part No.	Description
1	3	A-12112	Screw
2	1	A-13546	End Plug Retainer
3	1	A-13363	Washer
4	1	A-13296	Screw
5, 6, 7, 8	1	A-60102-20	Piston Softener & Filter
9, 10	1	A-60125	Seals (5) & Spacers (4) Assy.
11	1	A-61400-34	Valve Body Assembly, 3/4" Dist.
12	4	A-13305	O-ring, Adapter Coupling
13	2	A-19228	Adapter Coupling
14, 15	2	A-13255-FT	Kit Adaptor Clip for AQT-56 FT
	2	A-13255-ST	Kit Adaptor Clip for AQT-56 ST
	2	A-13255-SM	Kit Adaptor Clip for AQT-56 SM
16	1	A-187706	Yoke, Plastic, 1"
	1	A-187706-02	Yoke, Plastic, 3/4"
17	1	A-13304	O-ring, Distributor Riser Tube
18	1	A-12281	O-ring, Top of Tank
19	1	A-56247	Drain, Quick Connector, Elbow, 1/2" Tubing
20	1	A-01019	O-ring, DLFC
21*	1	A-120XX	DLFC Button
22	1	A-50011	Locking Clip, Drain QC
23	1	A-13245	BLFC Button Retainer
24**	1	A-120XX	BLFC Button
25, 26, 27	1	A-13244	Brine Line Quick Connector 3/8" Tubing
28	2	A-13315	Screw
29	1	A-13166	Injector Cover
30	1	A-13303	O-ring, Injector Cover
31	1	A-01002	O-ring, Injector (Included w/ Injector)
32***	1	A-10225-X-N	Injector
33	1	A-01017	O-ring, Injector (Included w/ Injector)
34	1	A-56226	Screen, Injector
35	1	A-13163	Injector Body
36	2	A-13301	O-ring
37	1	A-13497	Air Dispenser
38	1	A-12638	O-ring
39 - 45	1	A-60032	Brine Valve Assy
46	1	A-13918	BLFC Plug
47	1	A10913BLK-02	Injector Black Capped
48	1	A-13857	Brine Valve Plug

### \* DLFC Button Options

A-12085	DLFC Button - 1.2 gpm
A-12086	DLFC Button - 1.5 gpm
A-12087	DLFC Button - 2.0 gpm
A-12088	DLFC Button - 2.4 gpm
A-12089	DLFC Button - 3.0 gpm
A-12090	DLFC Button - 3.5 gpm
A-12091	DLFC Button - 4.0 gpm
A-12092	DLFC Button - 5.0 gpm

### \*\* BLFC Button Options

A-12093	BLFC Button - 0.125 gpm
A-12094	BLFC Button - 0.25 gpm
A-12095	BLFC Button - 0.5 gpm
A-12097	BLFC Button - 1.0 gpm
<b>*** Injectors</b>	
A-10225-0-N	Injector Assy, #0, Red (7" and 8" tank) for AQT-56
A-10225-1-N	Injector Assy, #1, White (9" and 10" tank) for AQT-56
A-10225-2-N	Injector Assy, #2, Blue (12" tank) for AQT-56
A-10225-3-N	Injector Assy, #3, Yellow (13" and 14" tank) for AQT-56

**Assembly Part Number**  
 A-60626, Turbine Assy. 3/4"

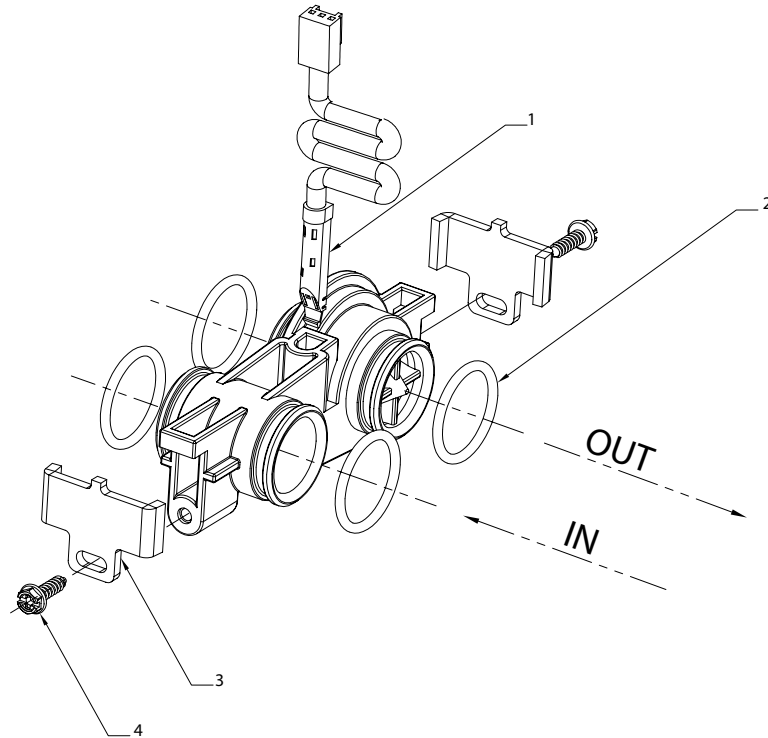

Item No.	Quantity	Part No.	Description
1	1	A-19791-01	Meter Cable, Turbine AQT-56SE
2	4	A-13305	O-ring
3	2	A-13255-SE	Adapter Clip
4	2		

# Valve Wiring

Diagram

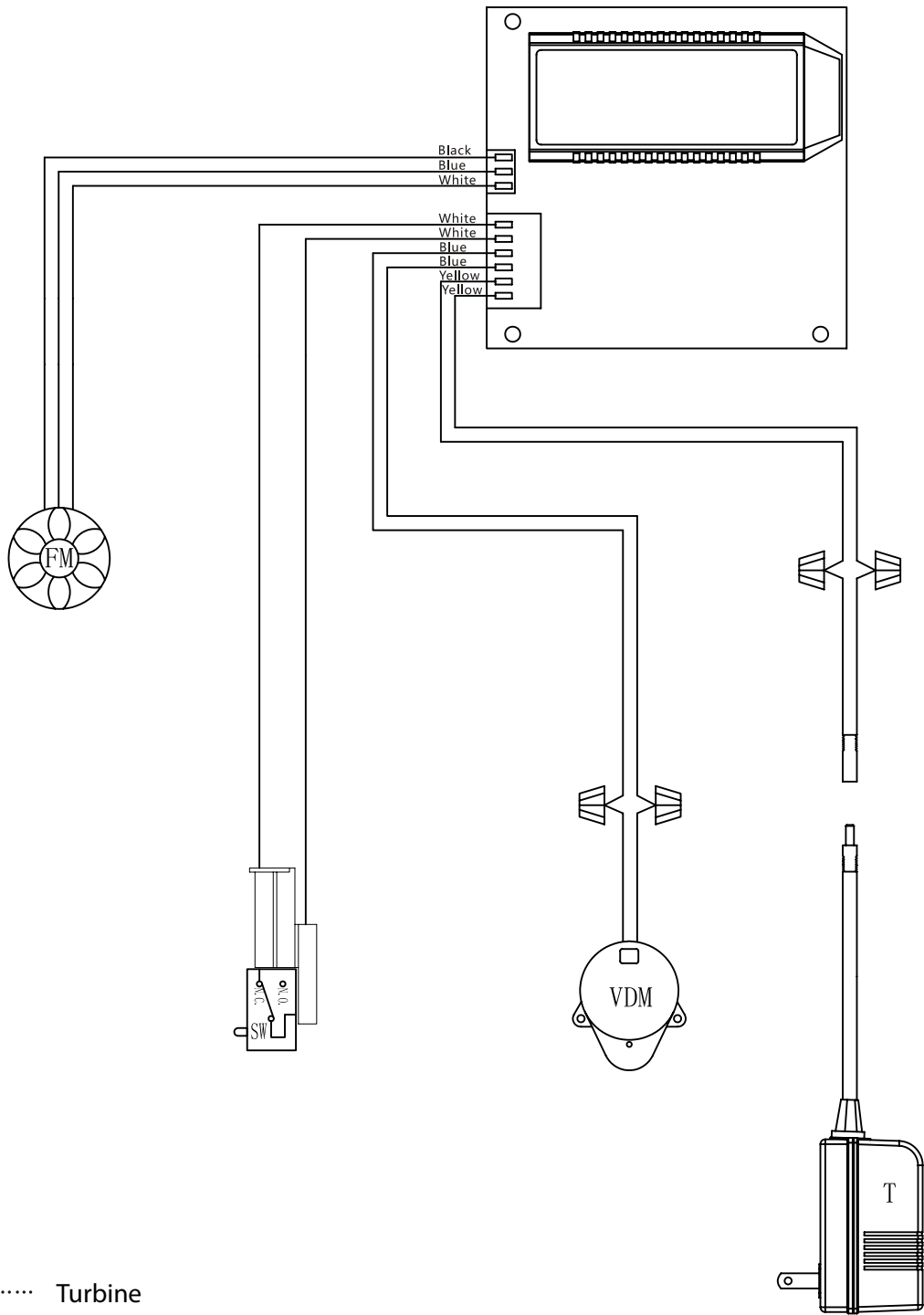

- FM ..... Turbine
- SW ..... Micro Switch
- VDM ..... Motor 24V
- T ..... Transformer (24V)

## Troubleshooting

Problems, Cause & Corrections

Problem	Cause	Correction
1) The control fails to Regenerate automatically	A) Disconnected meter cable	A) Reconnect the meter cable
	B) Transformer damaged	B) Replace the transformer
	C) Electronic controller or sensor damaged	C) Replace or repair
2) Regeneration at wrong time	A) Timer improperly set, due to power failure	A) Reset timer
3) loss of capacity	A) Increase draw water hardness	A) reset unit to the new capacity
	B) Brine concentration or quantity	B) Keep brine tank full of salt at all times. Clean it yearly. Salt may be bridged. If using a salt grid Plate insure refill water is over it
	C) Rinse fouling	C) Consolidate the rinse tank, clean the rinse and prevent future fouling
	D) Poor distribution, channeling (Uneven bed service)	D) Check distributors and backwash flow
	E) Internal control leak	E) Replace the spacer, seal or piston
	F) Ageing of rinse	F) Check for resin oxidation caused by Chlorine. Mushy resin
	G) Loss of rinse	G) Check for correct bed depth. Broken distributors. Air or gas in bed: Well gas Eliminator loose brine line
4) Poor water quality	A) Check items listed in Problem # 3	A) Check items listed in Correction # 3
	B) Bypass is open	B) Close the bypass
	C) Channeling	C) Check for too slow or high service flow
5) Excessive salt use	A) High salt setting	A) adjust salt setting
	B) Excessive water in brine tank	B) refer to problem # 7 tank
6) Loss of water pressure	A) Fouling of inlet pipe	A) Clean or replace the pipeline
	B) Fouled resin	B) Clean the resin. Pretreat to prevent
	C) Improper backwash	C) Too many resin fines. Reset the flow rate and time of backwash
7) Excessive water in brine tank	A) Plugged drain line	A) Check drain line and clean flow control
	B) Brine valve plugged or damaged	B) Clean or replace the brine valve
	C) Injector plugged	C) Clean injector, replace injector screen
	D) Low inlet water pressure	D) Increase water pressure to allow Injector to perform properly
8) Softener fails to brine draw	A) Plugged drain line	A) Clean drain line and flow control
	B) Plugged injector	B) Clean or replace the injector and screen
	C) No water in the brine tank	C) Check for restriction in B.L.F.C. Ensure Safety float is not stuck
	D) Low water pressure	D) Increase water pressure
	E) Brine line injects air during brine draw	E) Check brine line for air leaks
	F) Internal control leak	F) Check seal, spacer and piston for scratches and dents
9) Control cycles continuously	A) Faulty timer	A) Replace timer
10) Continuous flow to drain	A) Foreign material in the control	A) Call dealer. Clean valve, rebuild unit
	B) Internal control leak	B) Same as above
	C) Piston jammed in brine or back wash position	C) Same as above





---